



POSTERBOOK

LIFT DOOR OPERATORS SORTED BY MANUFACTURER



EVERYTHING
IN STOCK

ALWAYS FAIR AND
ACCOMMODATING

ONE PHOTO IS ENOUGH –
WE CREATE AN OFFER

THE RIGHT SOLUTION
FOR EVERY DOOR

ALWAYS REACHABLE
AT SHORT NOTICE

AKRON center

2025/1



ALJO Sinus

2025/2



ARTIS center

2025/3

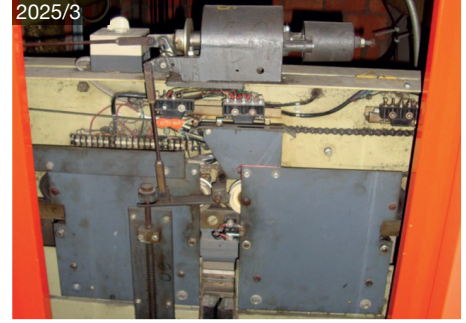

AUTÜR telescope

2025/4

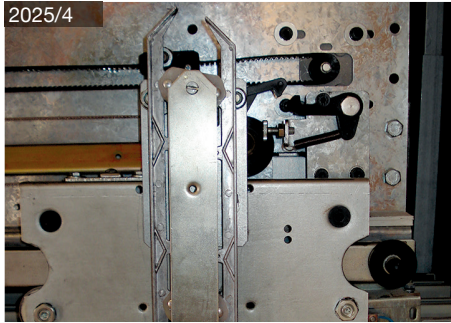

BAUER 1

2025/5

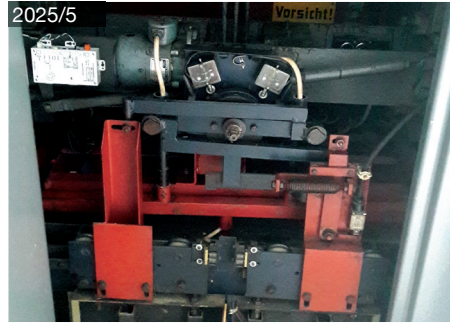

Bauer 2

2025/6

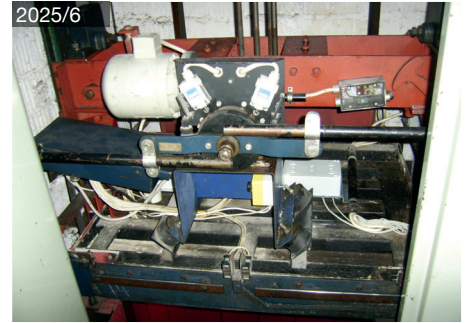

Bauer 3

2025/7

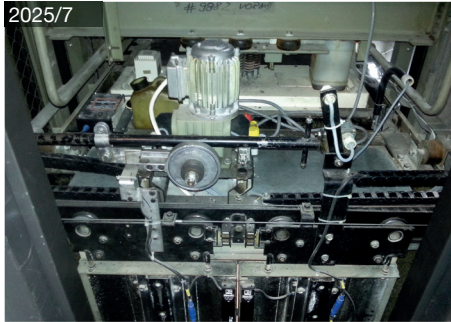

Bauer 4

2025/8



CAMUS center

2025/9

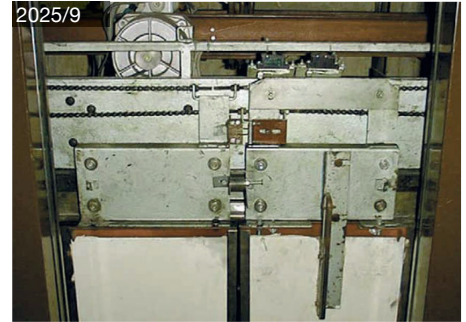

Camus telescope

2025/10



CANOSSA

2025/11

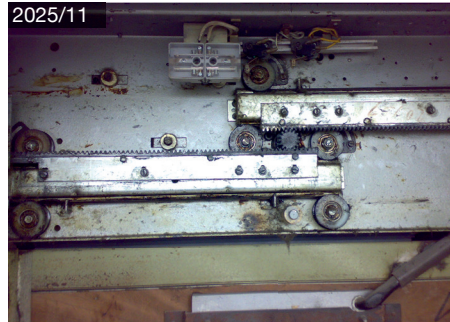

Canossa telescope

2025/12



CEITA Eleflex center

2025/13

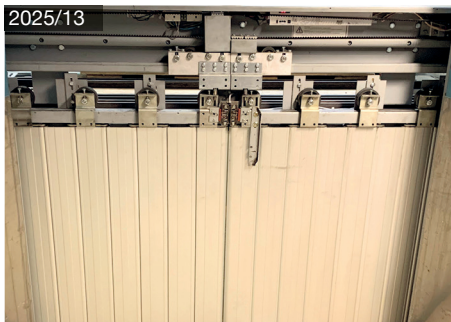

Ceita Elematic center

2025/14

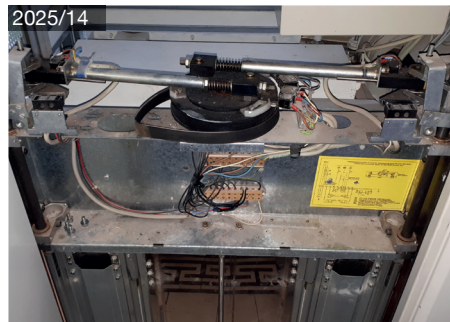

CENIA 91

2025/15

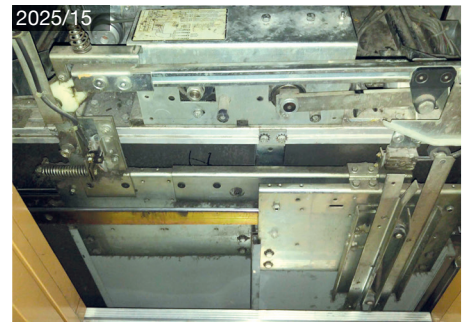

Cenia Tacos
2025/16

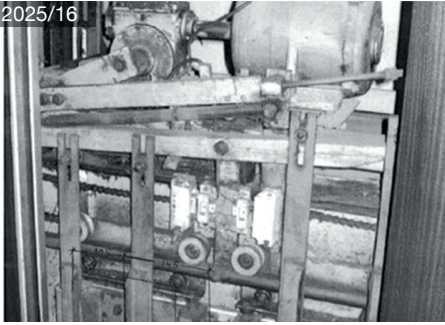

CERNY center
2025/17



Cerny telescope
2025/18

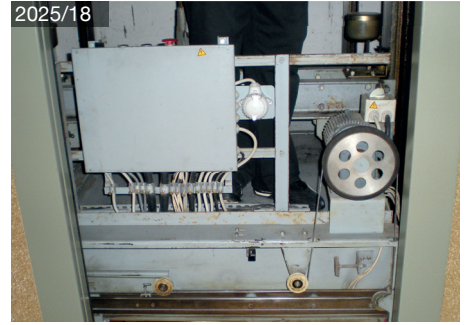

CMM toothed belt center
2025/19

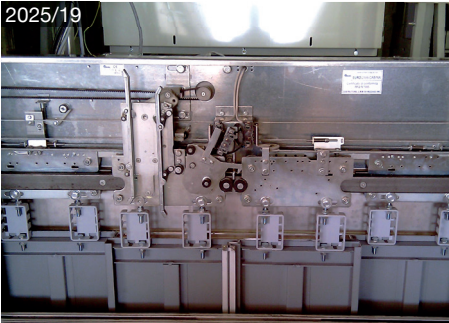

CMM Sinus Lever Drive
2025/20



CMM tooth belt telescope
2025/21

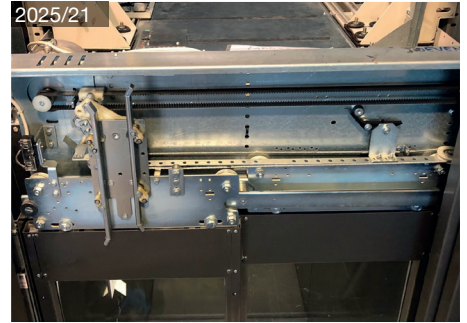

DDR center
2025/22

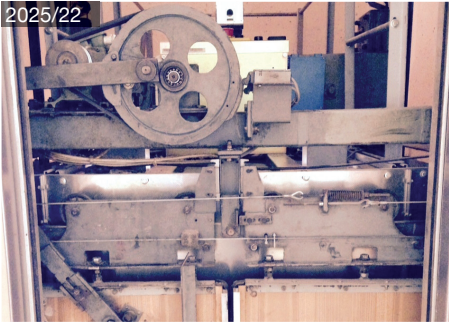

DDR telescope
2025/23



DEWHURST telescope
2025/24



DOPPLER telescope
2025/25

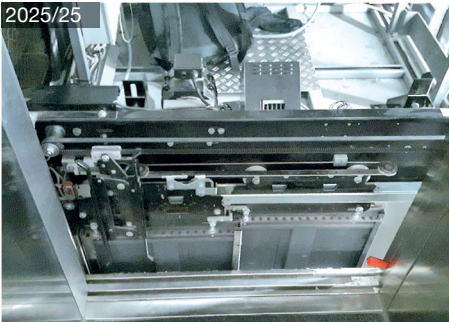

DOVER HD telescope
2025/26



DUPAR telescope
2025/27

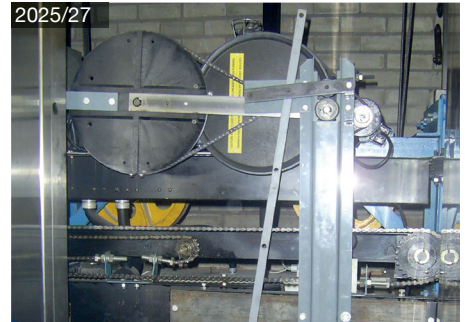

ELEVATOR Trading Marathon 100
2025/28



Elevator Trading Marathon 200
2025/29

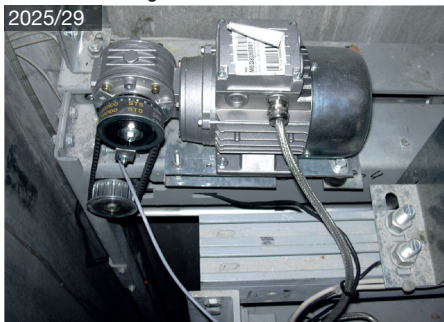

Elevator Trading Marathon 3000
2025/30



ELEX Aurex

2025/31

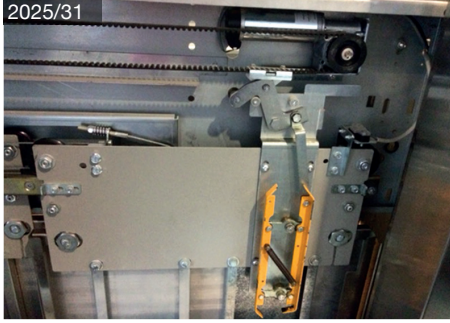

ELIT Electronic center

2025/32



EXPRESS cyclonical

2025/33

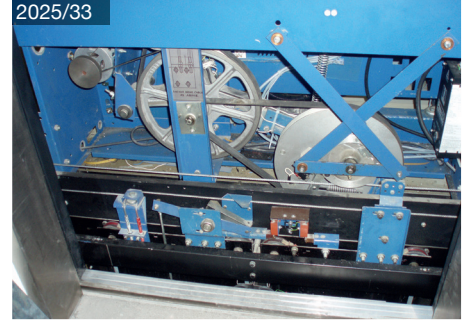

FALCONI

2025/34



Falconi center

2025/35

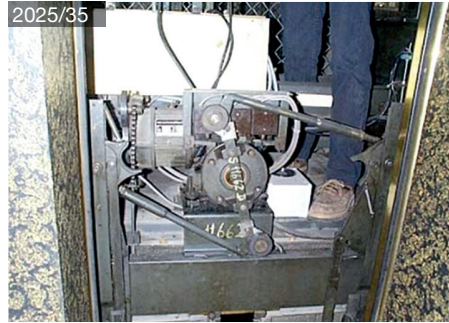

FERMATOR AS6DE

2025/36



Fermator Folding door center

2025/37



Fermator Sinus telescope

2025/38

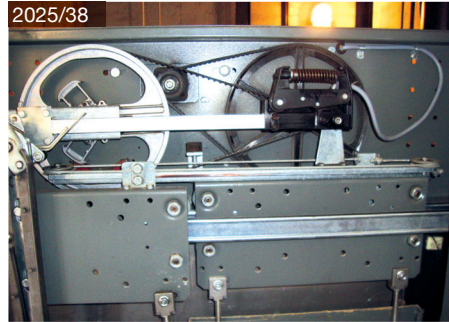

Fermator VWF center

2025/39

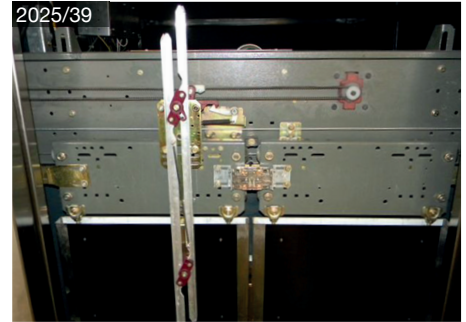

FIAM Kette telescope

2025/40

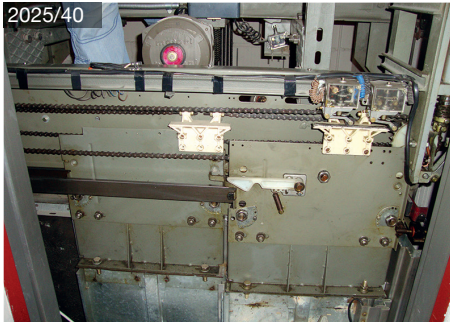

Fiam Sinus center

2025/41



FORSID 85

2025/42

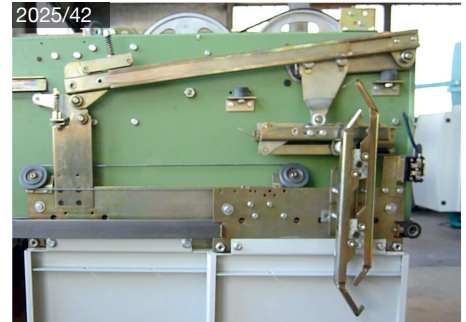

Forsid 85N center

2025/43



Forsid 85N telescope

2025/44



Forsid 92 VF center

2025/45



Forsid 92 VF telescope



Forsid Europa



Forsid ZIP center



Forsid ZIP telescope



FOURINI

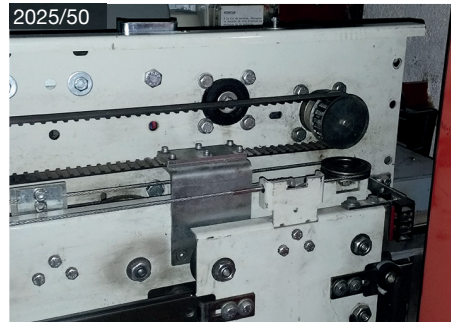

Fourini telescope

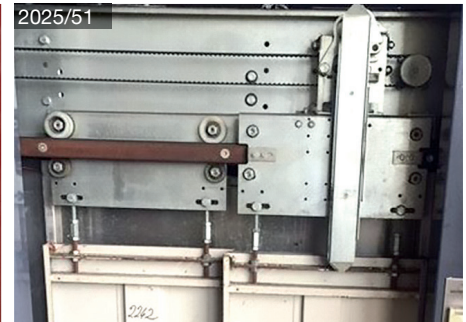

FUJITEC telescope

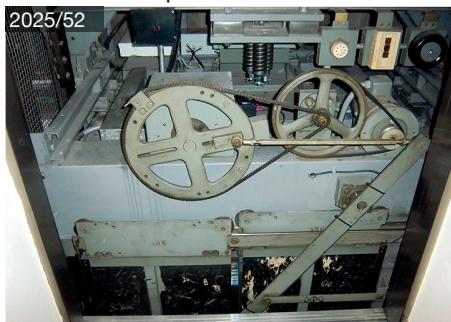

FÜLLER UND KNÖRZER



GAL center

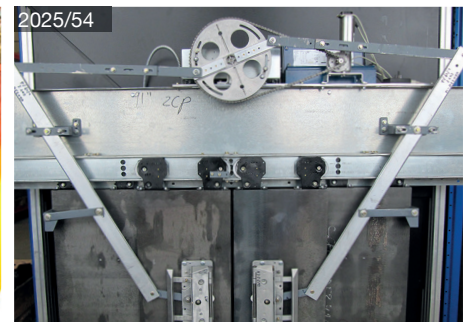

GAL telescope



GAL toothed belt

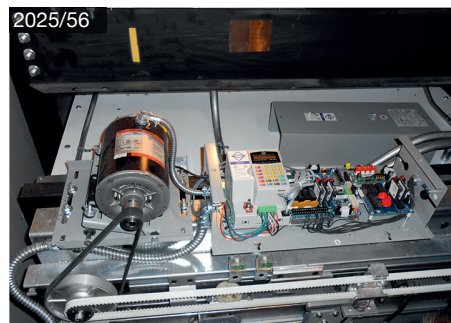

GILGEN folding door

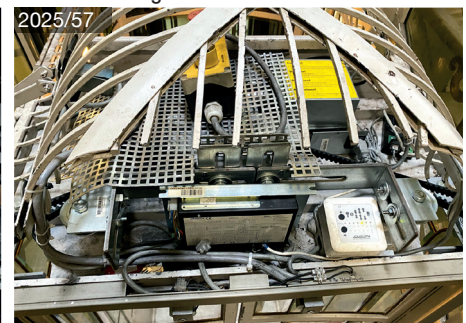

GMV VICTORY



GMV Victory center



HAACK telescope



HAMMONG AND CHAMPNESS DC68 telescope

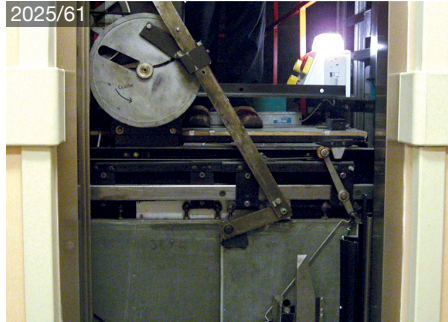

HAUSHAHN chain telescope

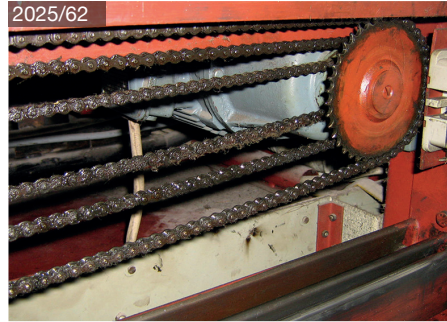

Haushahn Logos telescope

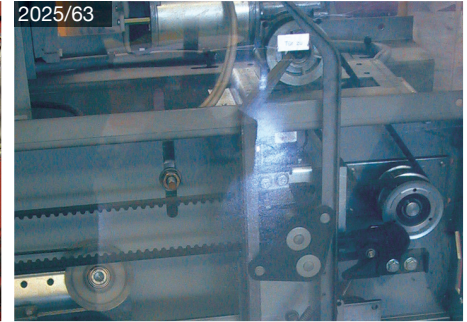

Haushahn P41 telescope



Haushahn TASS80 telescope

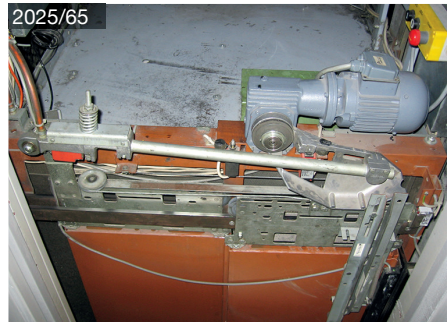

Haushahn TS54 telescope



Haushahn TSS72 telescope

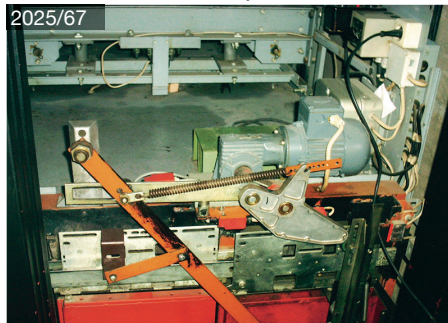

Haushahn ZS54 center

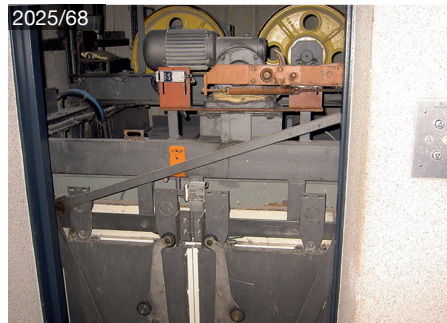

Haushahn ZSS72 center

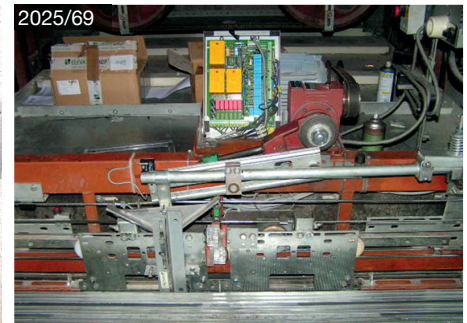

HÄVEMEIER UND SANDER Kat 7x telescope



Hävemeier und Sander KAT69 telescope

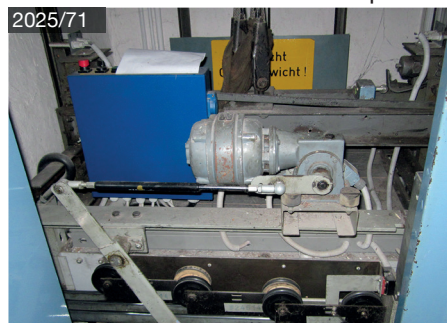

HIRO center

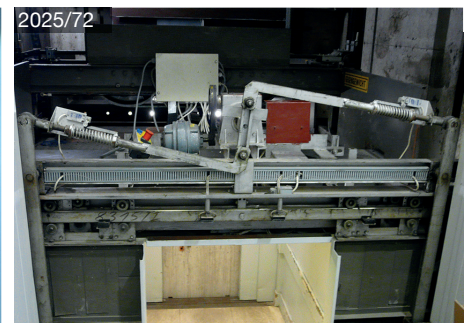

Hiro central telescope



Hiro chain telescope



Hiro telescope



HITACHI

2025/76



HÜTTER vertical door VKT

2025/77

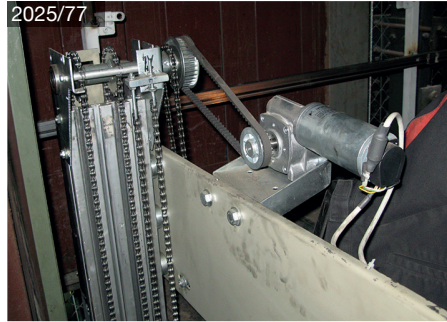

Hütter telescope

2025/78



HYUNDAI telescope

2025/79



IGV 2010 Linear 1200

2025/80



IGV center

2025/81



IGV telescope

2025/82



KASPER center

2025/83

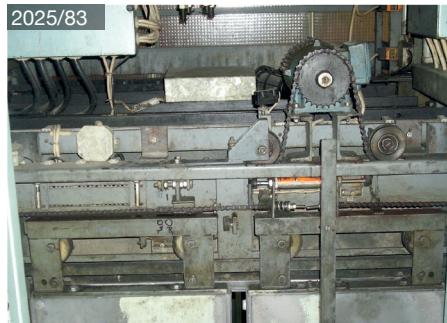

Kasper telescope

2025/84



KIEKERT

2025/85



KLEEMANN 1 telescope

2025/86



Kleemann 2 telescope

2025/87



KLEINDIENST telescope

2025/88



KOCH 1 telescope

2025/89

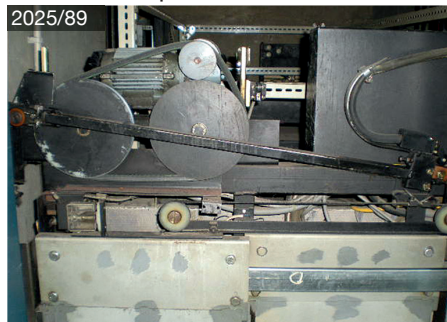

Koch 2 telescope

2025/90

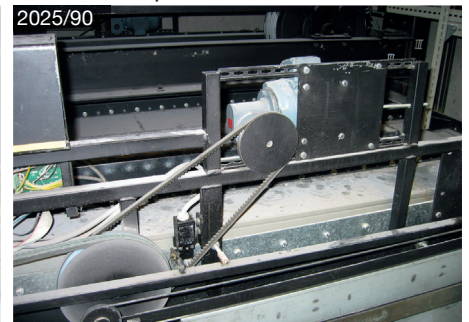

Koch Sinus telescope

2025/91

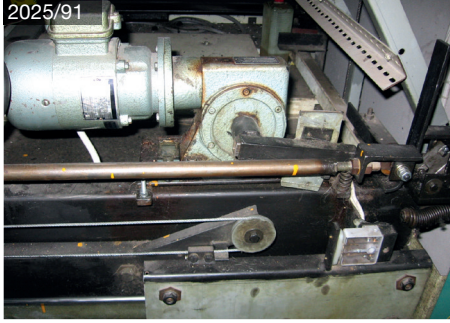

KONE ADB center

2025/92

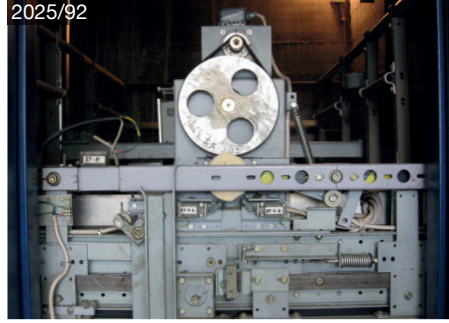

Kone ADC center

2025/93



Kone ADC telescope

2025/94

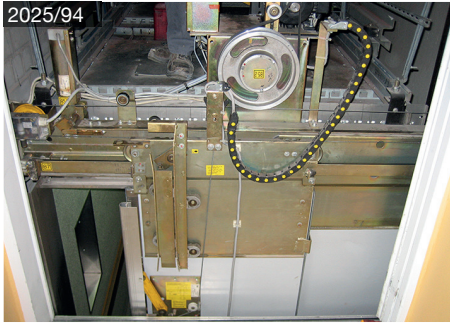

Kone ADE center

2025/95

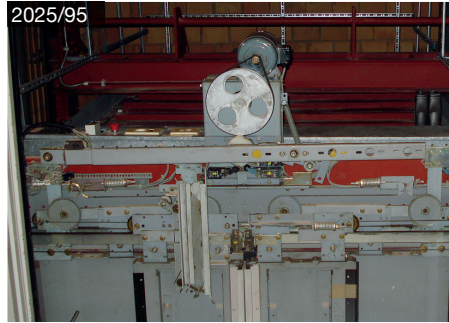

Kone ADE telescope

2025/96

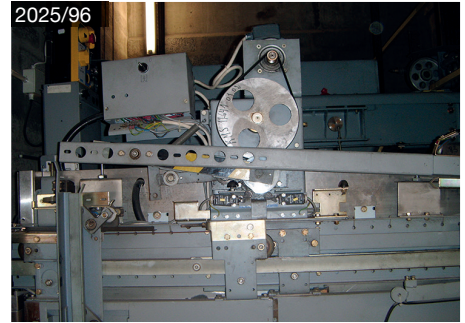

Kone ADF center

2025/97

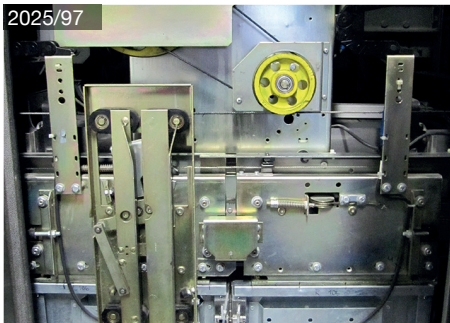

Kone ADF telescope

2025/98

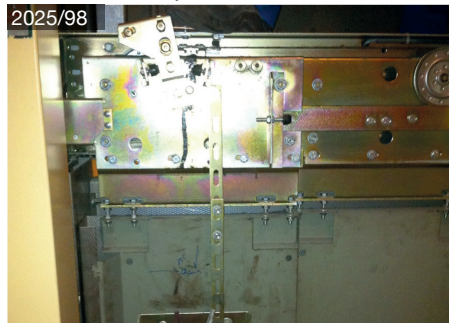

Kone ADM center

2025/99

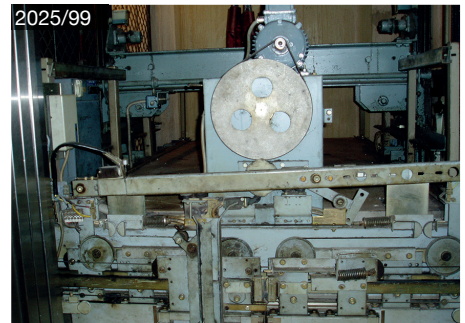

Kone AMD Athena

2025/100

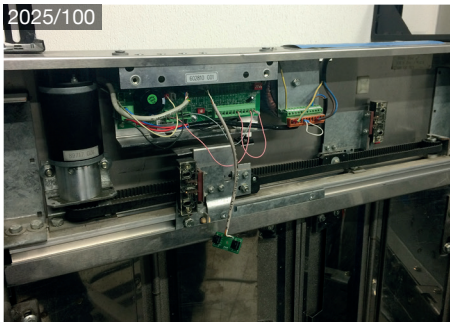

Kone ADM telescope

2025/101



Kone ADR telescope

2025/102

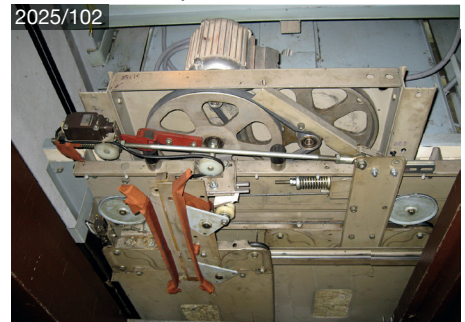

Kone ADV telescope

2025/103



Kone ADX center

2025/104



Kone ADX telescope

2025/105



Kone AMD center

2025/106



Kone AMD telescope

2025/107

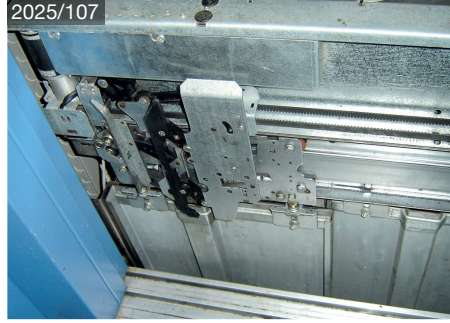

Kone Fiam center

2025/108

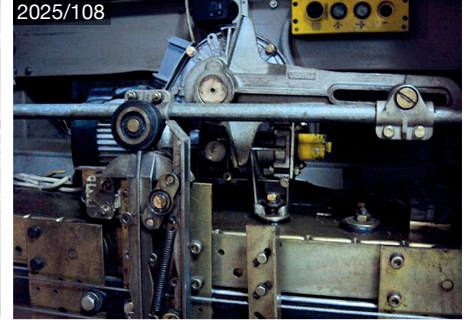

Kone Isola center

2025/109

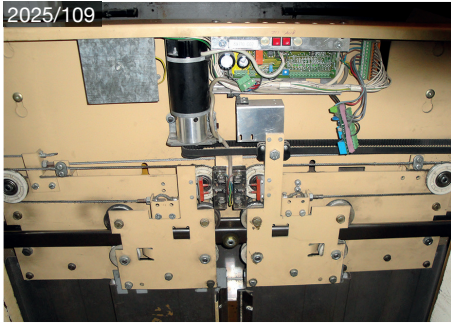

Kone OAK 45 telescope

2025/110



KRAMER Folding Door

2025/111

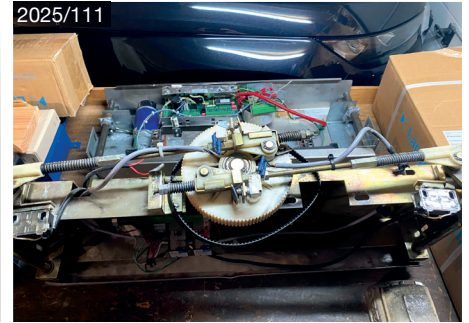

KRAMES Krafrimatic Dentamatic 3K TS telescope

2025/112



Krames KraphiFalt V4FZ center

2025/113

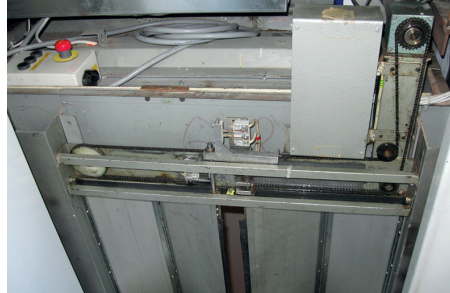

Krames Tor telescope

2025/114



LG ELEVATOR Lucky Goldstar center

2025/115

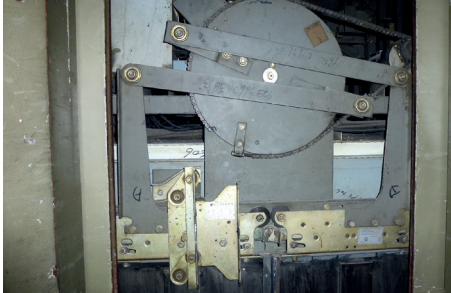

LG Elevator Lucky Goldstar telescope

2025/116



LIFTCOMP center

2025/117

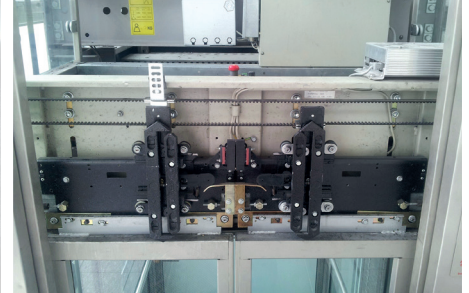

Liftcomp telescope

2025/118

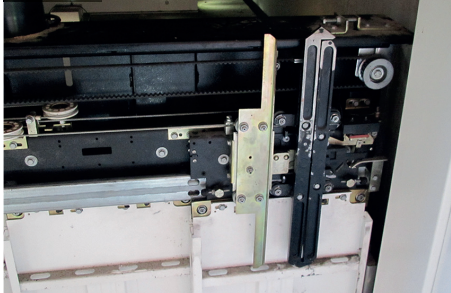

LÜTHI center

2025/119

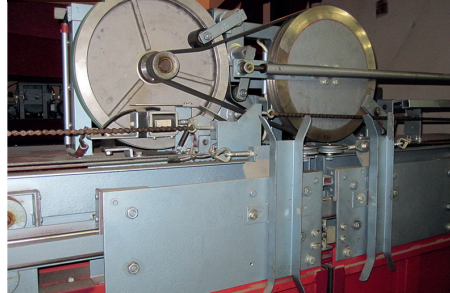

LUTZ telescope

2025/120



LYNGE&JENSEN dormaskine

2025/121



Lynge&Jensen Sinus Lever Drive

2025/122

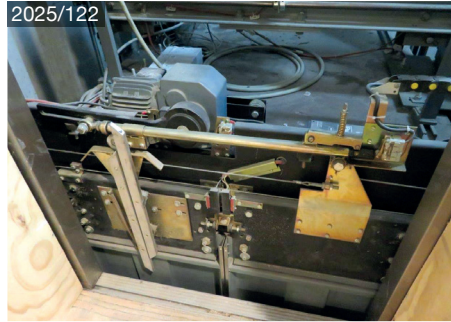

MAC Marathon telescope

2025/123

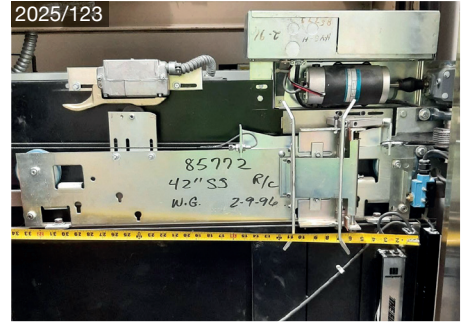

MACPUARSA Sinus Lever Drive center

2025/124



Macpuarsa toothed belt

2025/125

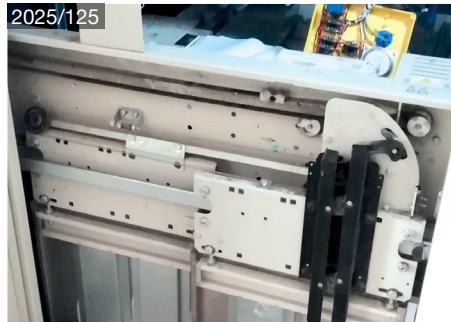

MAN 1 telescope

2025/126

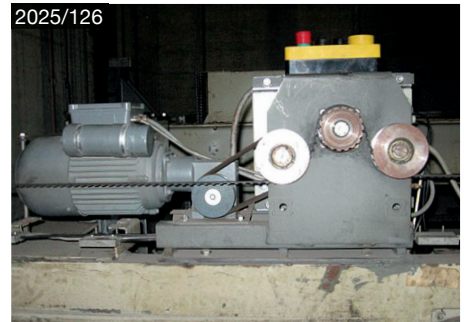

MAN 2 center

2025/127



MAN 3 telescope

2025/128

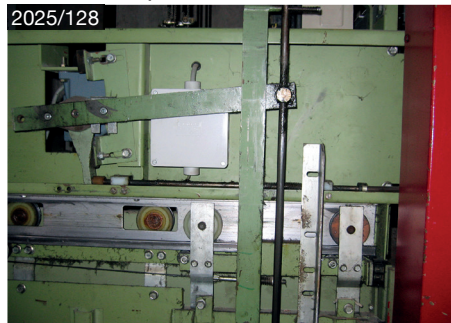

MAN 4 telescope

2025/129



MASORA AS center

2025/130

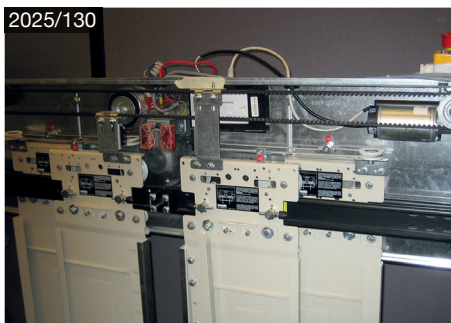

MEILLER Drahtseil telescope

2025/131



Meiller MiDrive

2025/132



Meiller Round Door

2025/133

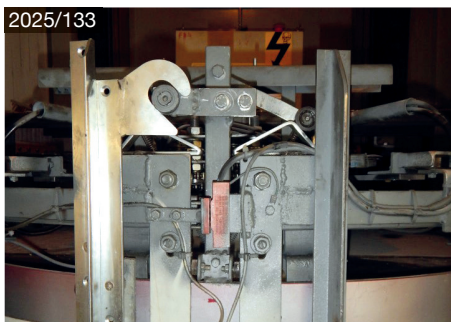

Meiller segment sliding door GTS6 central

2025/134



Meiller TTK spindle center

2025/135



Meiller TTK spindle telescope

2025/136



Meiller TTK32 telescope

2025/137



METRON Folding door

2025/138

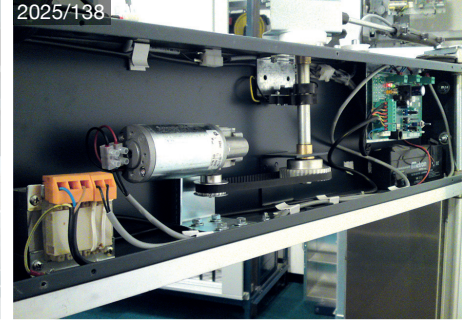

Metron telescope

2025/139



MITSUBISHI direct drive

2025/140

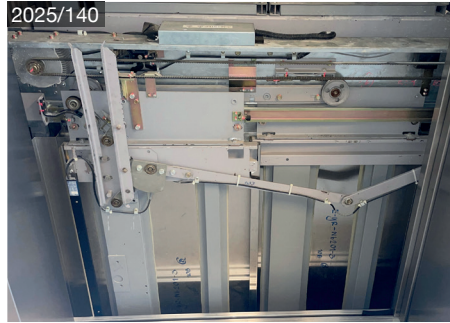

Mitsubishi HD

2025/141

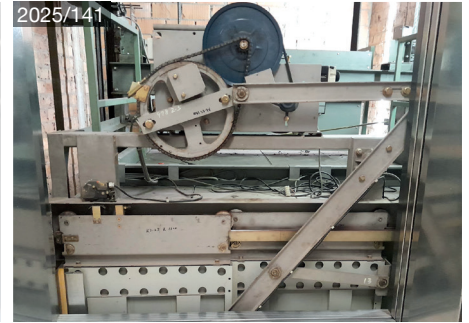

Mitsubishi indirect drive

2025/142



MOGILEV Door center typ 1

2025/143



Mogilev Door center typ 2

2025/144



MONITOR 85 telescope

2025/145



Monitor 85N center

2025/146



Monitor 85N telescope

2025/147



Monitor 92 VF center

2025/148



Monitor 92 VF telescope

2025/149



Monitor 99 VF

2025/150

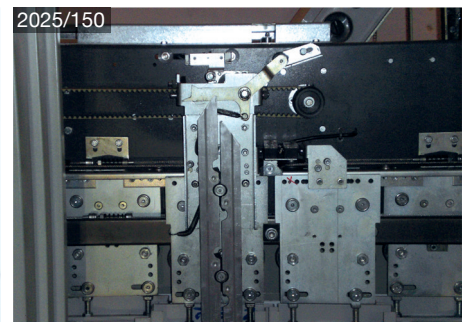

Monitor ZIP center

2025/151



Monitor ZIP telescope

2025/152

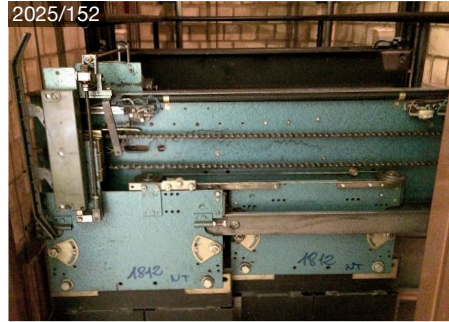

MOTALA

2025/153

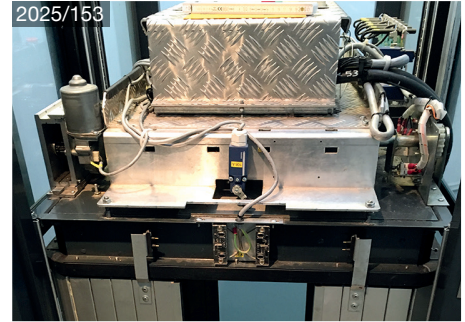

ORONA center

2025/154

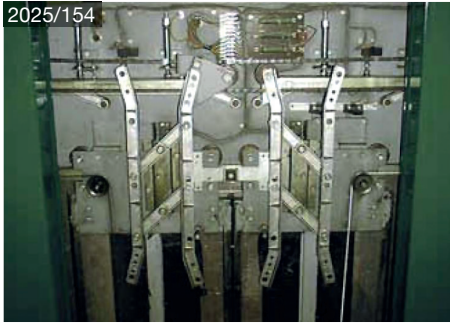

Orona telescope

2025/155

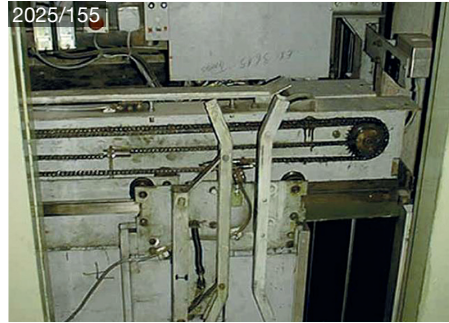

Orona toothed belt

2025/156

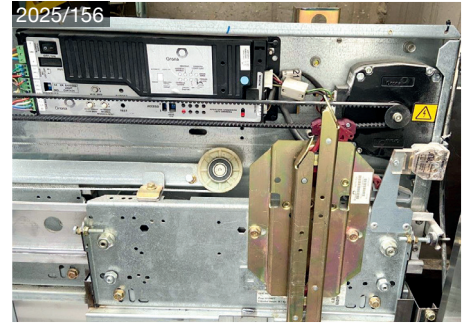

OSMA Typ 1 telescope

2025/157

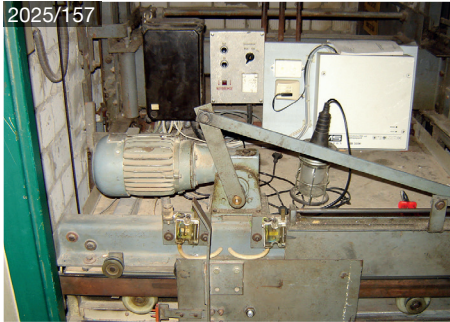

Osma Typ 2 TS5 center

2025/158



Osma Typ 3 TS6 telescope

2025/159

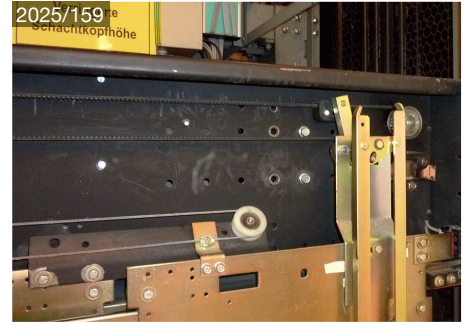

OTIS 6770-A center

2025/160



Otis 6940 center

2025/161



Otis 6970 center 2 flügelig

2025/162

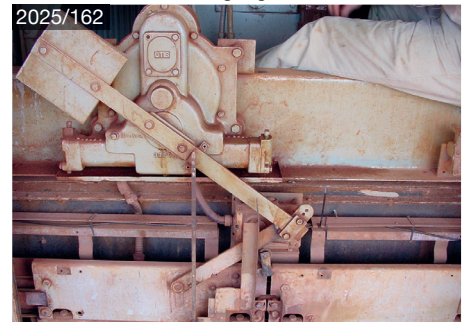

Otis 6970 center 4 flügelig

2025/163

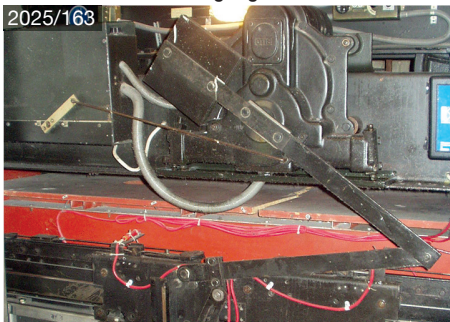

Otis 6970 New York center

2025/164



Otis 6970 telescope

2025/165



Otis 7300 telescope

2025/166



Otis 9550 center 1

2025/167

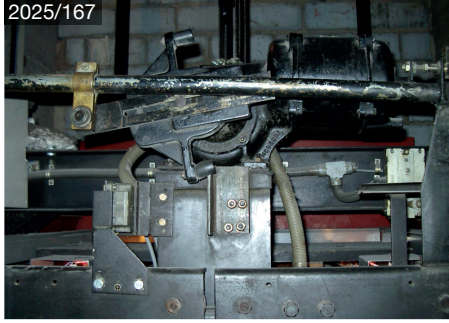

Otis 9550 center 2

2025/168

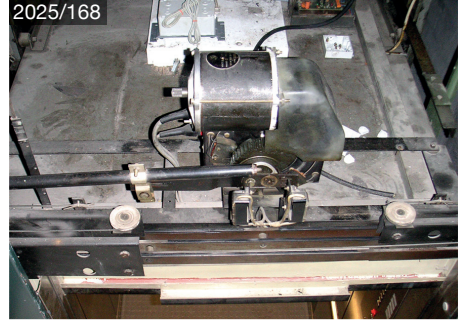

Otis 9550 Orly telescope

2025/169

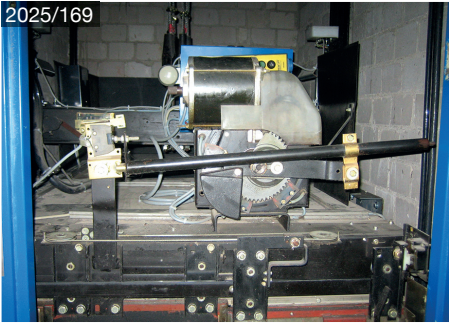

Otis 9550-T center

2025/170



Otis 9550-Y telescope

2025/171



Otis 9691 - Otis 9550CC telescope

2025/172



Otis 9691 telescope

2025/173

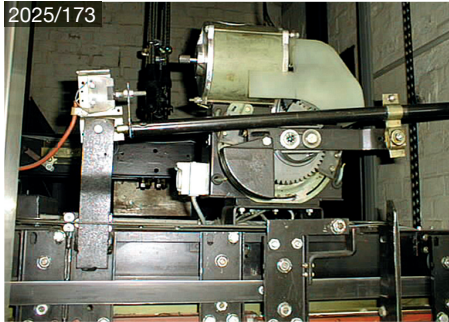

Otis 9940 telescope

2025/174

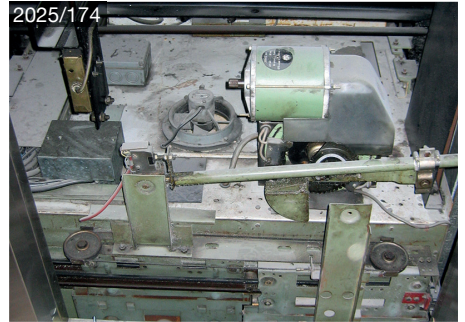

Otis 9940-H telescope

2025/175

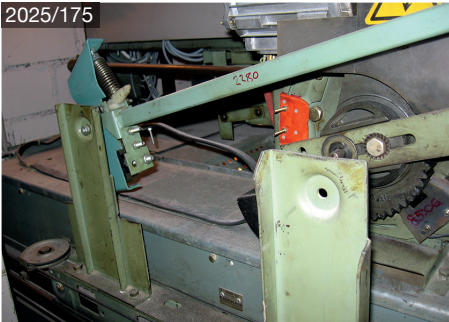

Otis AT120

2025/176

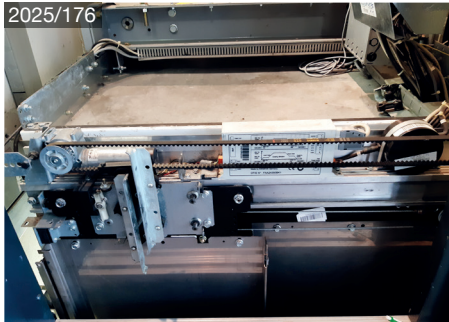

Otis D2000 telescope

2025/177

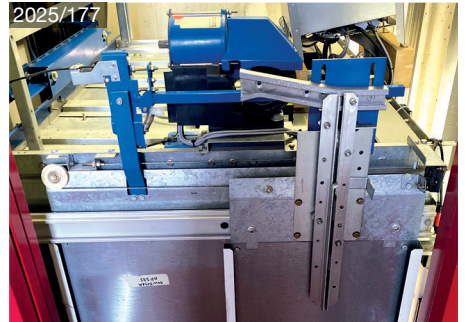

Otis D2200 center

2025/178

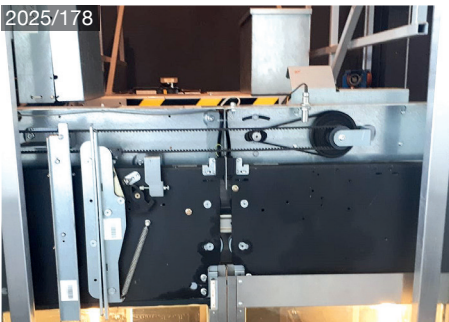

Otis D2200 telescope

2025/179



Otis D0 2000 center

2025/180



Otis DO 2000 telescope

2025/181



Otis GMP

2025/182

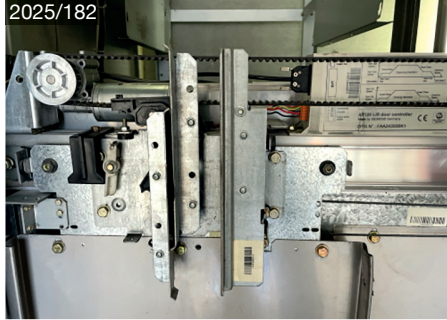

Otis MLI folding door

2025/183

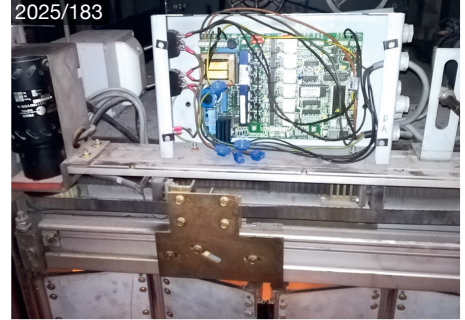

Otis MRDS telescope

2025/184



Otis Orly telescope

2025/185

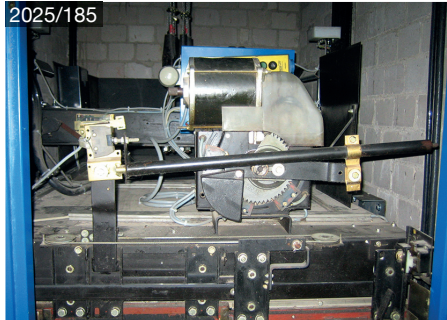

Otis OVL center

2025/186



Otis Protecta

2025/187



Otis RBS telescope

2025/188



Otis Vertica 3

2025/189



PEIGNEN A30 center

2025/190



Peignen A30

2025/191

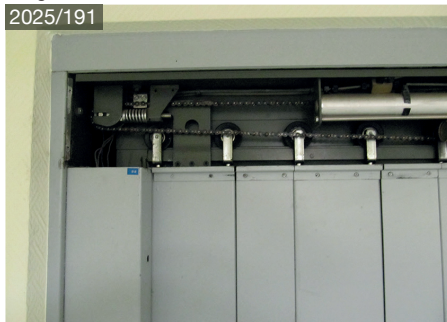

Peignen A45

2025/192



PRISMA Concord telescope

2025/193

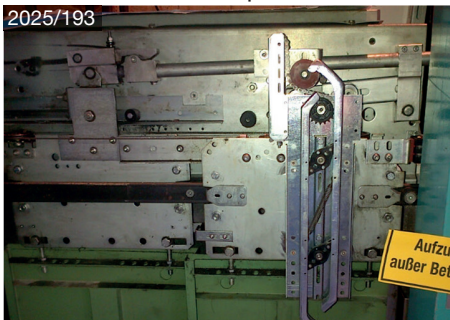

Prisma Linear DOS center

2025/194

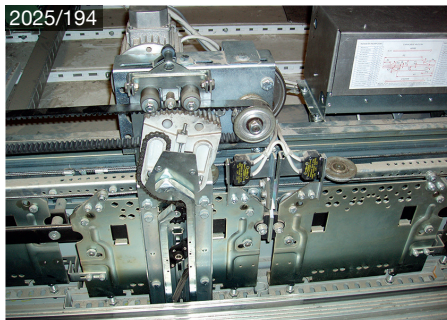

Prisma Linear DOS telescope

2025/195

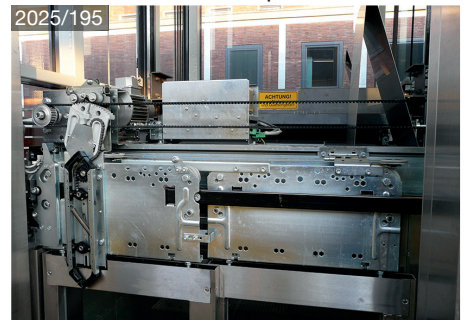

Prisma Micro MS40 telescope

2025/196

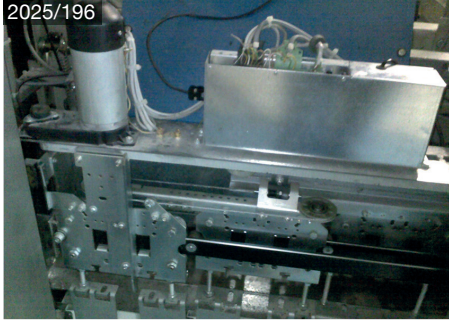

Prisma Sinus Concord

2025/197

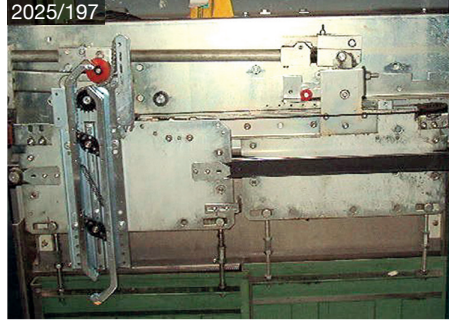

Prisma Sinus telescope

2025/198

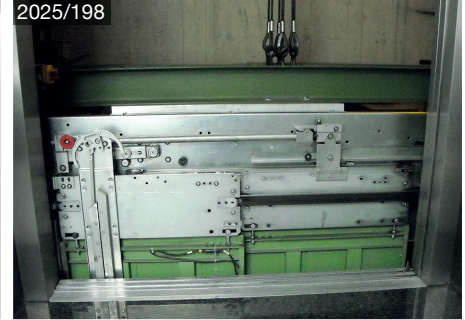

RATHGEBER Drahtseil center

2025/199



Rathgeber Drahtseil telescope

2025/200

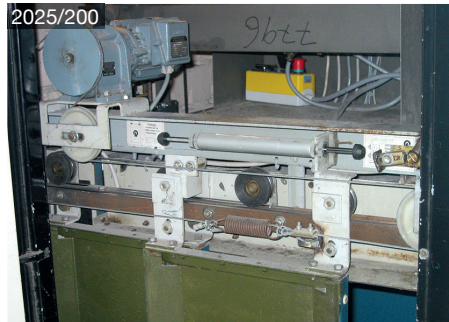

RHEINSTAHL-EGGERS-KEHRHAHN center

2025/201



Rhein Stahl-Eggers-Kehrhaahn REK chain

2025/202

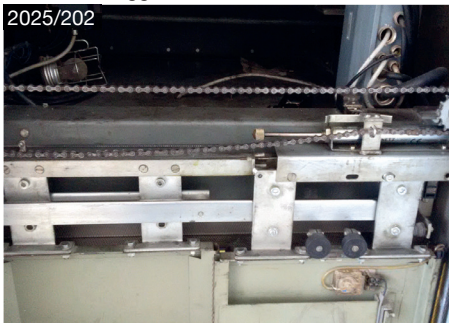

RIEDL 3 panel telescope

2025/203



Riedl RTK telescope

2025/204



Riedl RZK center

2025/205



ROUX-COMBALUZIER telescope

2025/206



SABIEM center

2025/207



SCHINDLER QK8 folding door

2025/208



Schindler QKS6 center telescope

2025/209

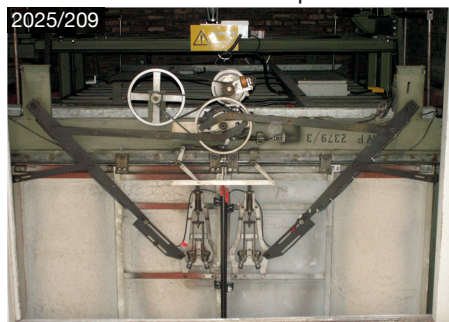

Schindler QKS6 telescope

2025/210

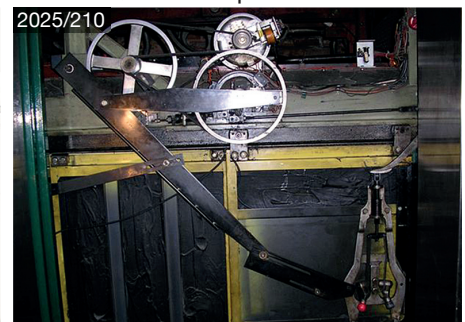

Schindler QKS7 center

2025/211

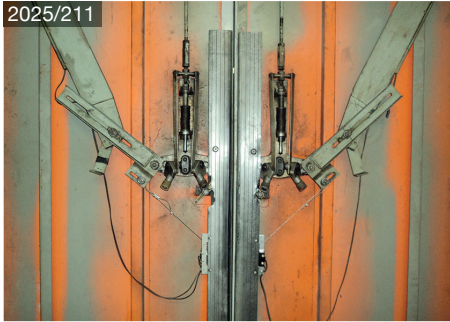

Schindler QKS8 center

2025/212

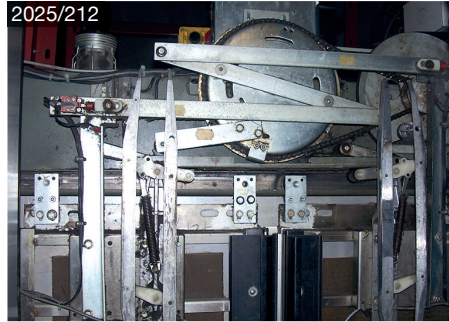

Schindler QKS8 telescope

2025/213

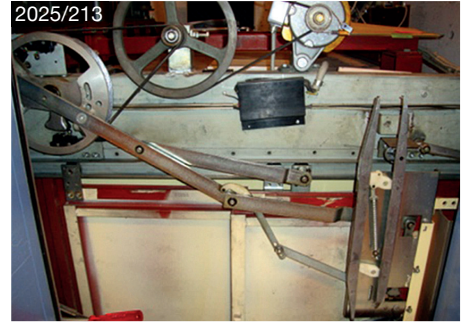

Schindler QKS9 center telescope

2025/214



Schindler QKS9 center

2025/215

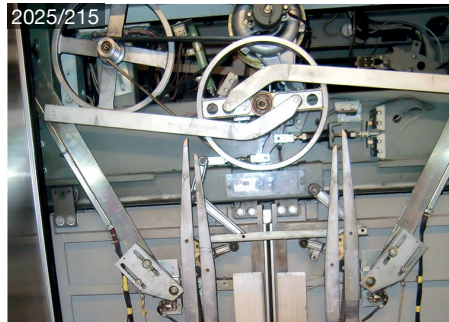

Schindler QKS9 telescope

2025/216



Schindler QKS10 center telescope

2025/217

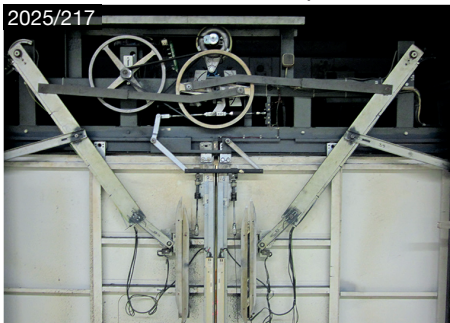

Schindler QKS11 telescope

2025/218



Schindler Varidor 10 telescope

2025/219

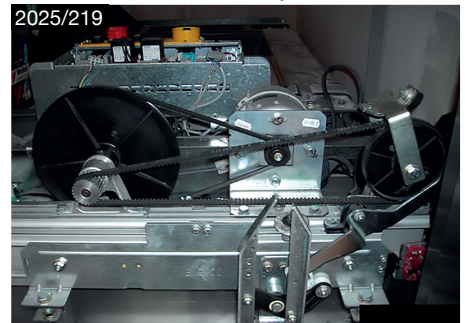

Schindler Varidor 15 telescope

2025/220



Schindler Varidor 20 center

2025/221

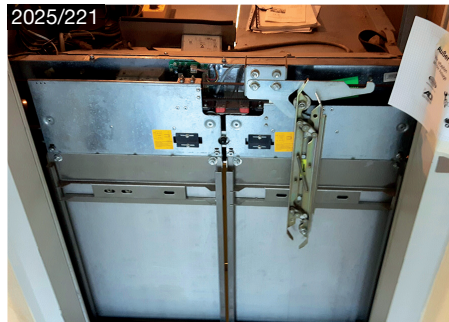

Schindler Varidor 20 telescope

2025/222

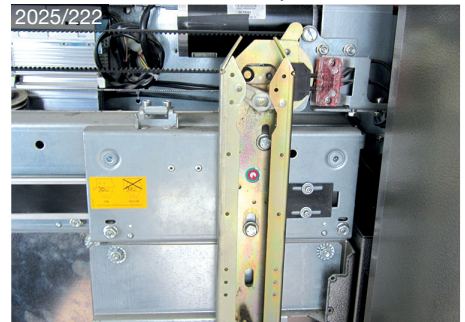

Schindler Varidor 30 center

2025/223

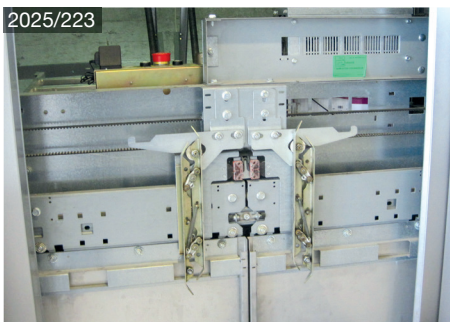

Schindler Varidor 30 telescope

2025/224

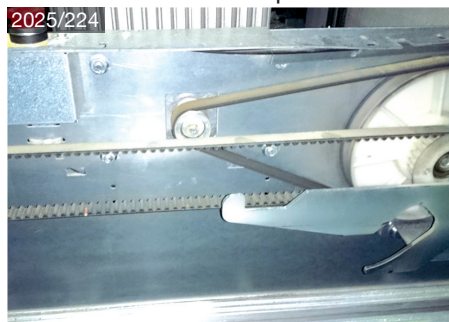

Schindler Varidor 50 telescope

2025/225

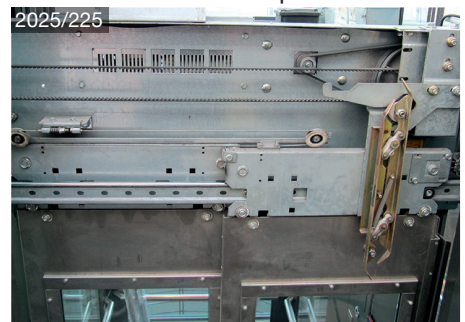

Schindler Varidor35 center

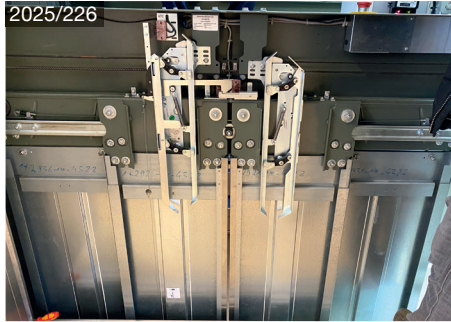

SCHLIEREN TA 2 center



Schlieren TA 2 telescope

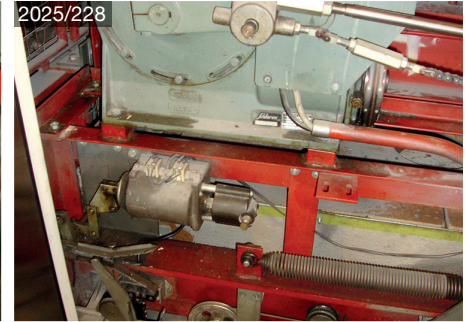

SCHMITT & SOHN chain telescope



Schmitt & Sohn crank arm

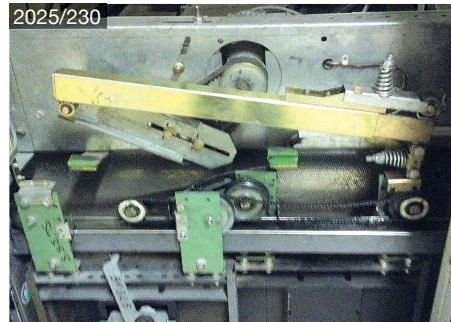

Schmitt & Sohn flat belt telescope



Schmitt & Sohn toothed belt center

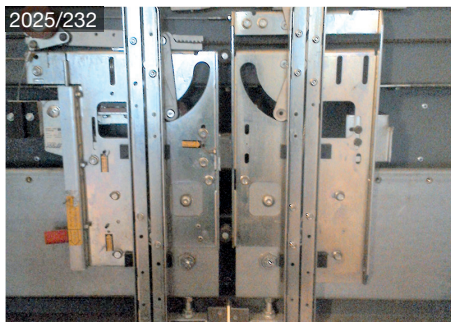

Schmitt & Sohn toothed belt telescope

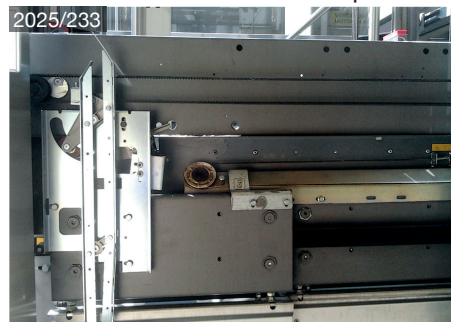

SCHMITT INGELHEIM center

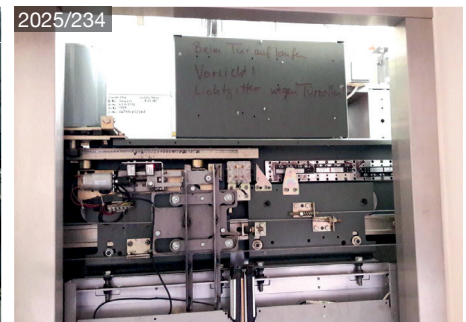

SELCOM 3201 Sinus telescope

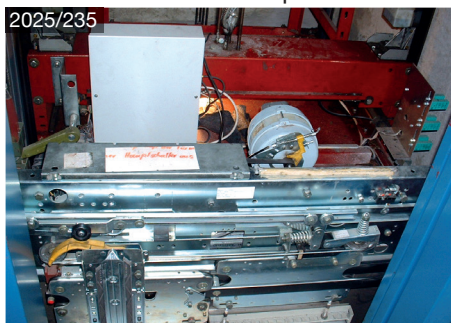

Selcom 3410 folding door



Selcom Hydrabelt center



Selcom Mosquito telescope

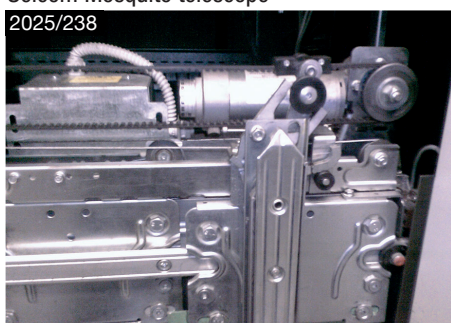

Selcom RCF1 center

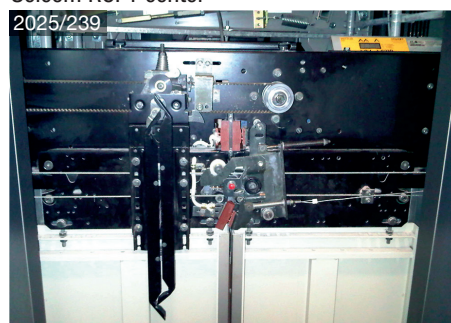

Selcom RCF1 center telescope

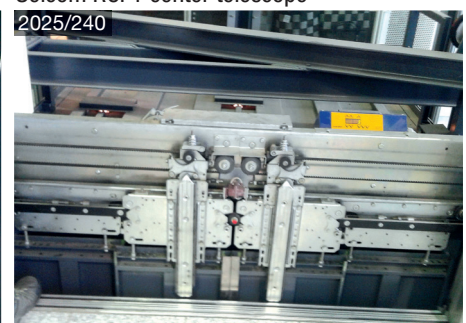

Selcom RCF1 telescope

2025/241



Selcom Round Door

2025/242



SEMATIC 3DC telescope

2025/243



Sematic 2000 Code B105AANX telescope

2025/244

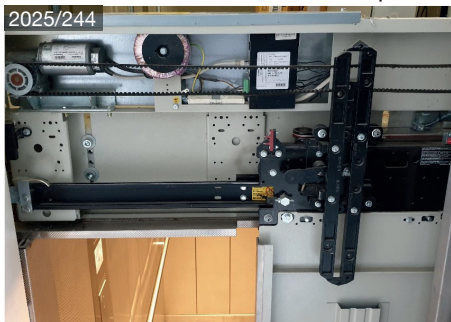

Sematic 2000 900H center

2025/245



Sematic 2000 900H telescope

2025/246

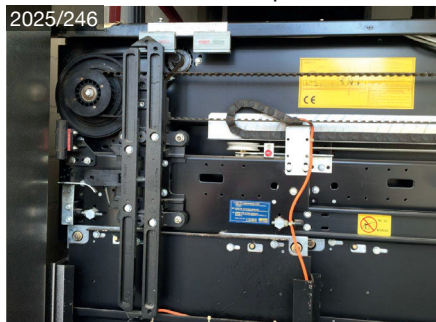

Sematic 2000 center ZMU

2025/247

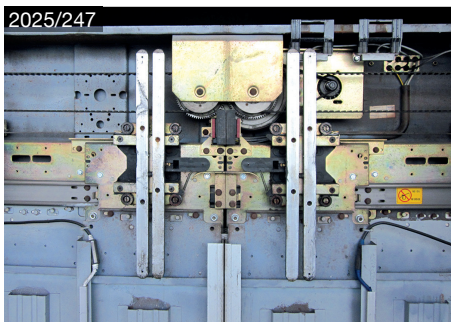

Sematic 2000 S8M center

2025/248

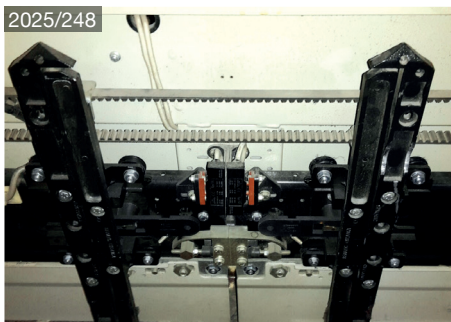

Sematic 2000 S8M telescope

2025/249

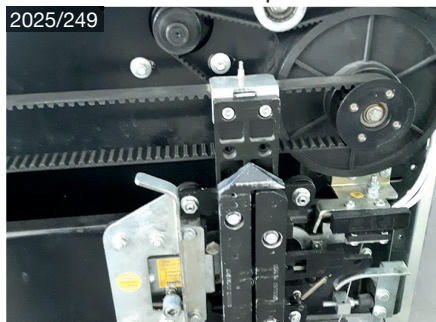

Sematic DC PWM SRS telescope

2025/250

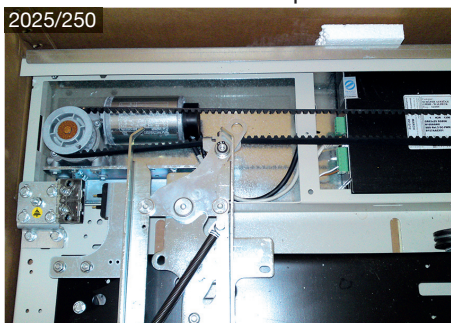

Sematic Minimotor

2025/251



SIEMENS AT

2025/252



Siemens AT25

2025/253



SLYDMA DELLERBA center

2025/254



Slycma DELLERBA telescope

2025/255



Slycma Dyn center

2025/256

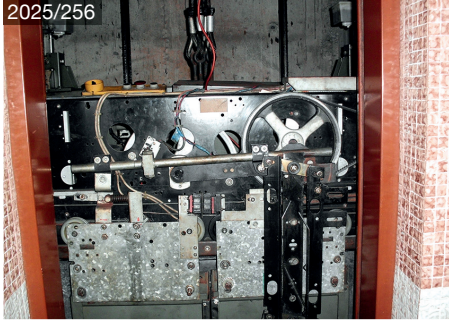

Slycma Dyn telescope

2025/257

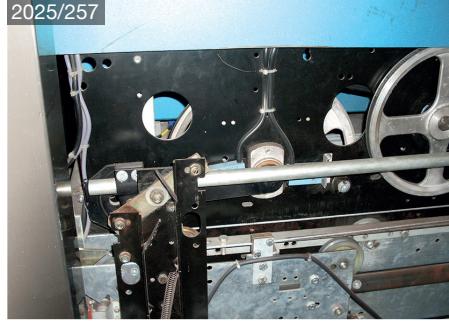

Slycma Ecosil center

2025/258

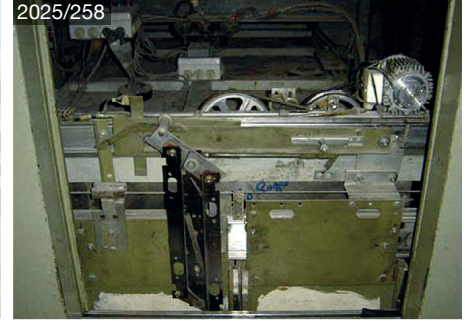

Slycma Jet center

2025/259

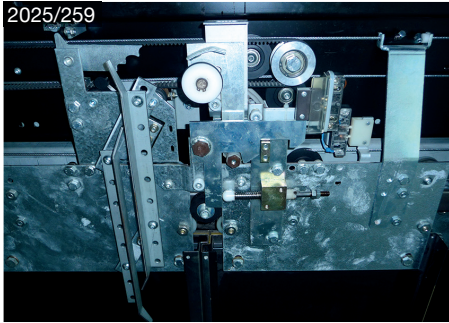

Slycma MiniPlyCab

2025/260



SORETEX center

2025/261

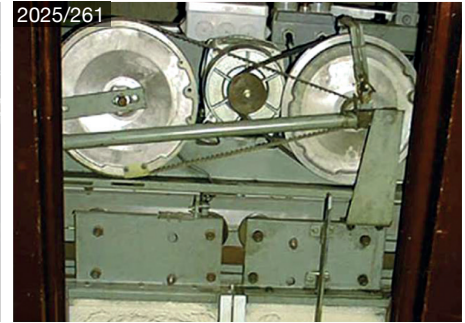

Soretex telescope

2025/262



STAHL center

2025/263



Stahl chain telescope

2025/264



STARLIFT 1 telescope

2025/265



Starlift 2 telescope

2025/266



Starlift 3 telescope

2025/267



SUZHOU Eshine telescope

2025/268

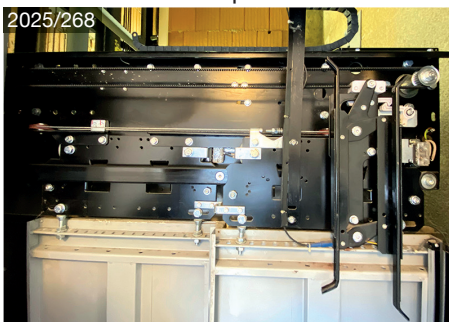

TACOS center

2025/269



TDE Walcz

2025/270

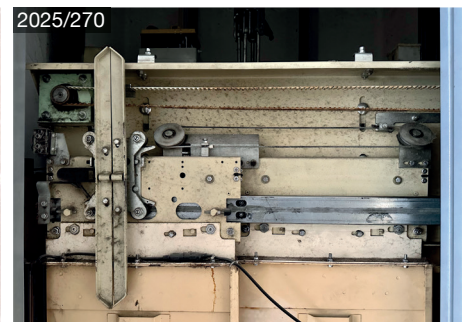

TELCO center
2025/271



TESIO telescope
2025/272

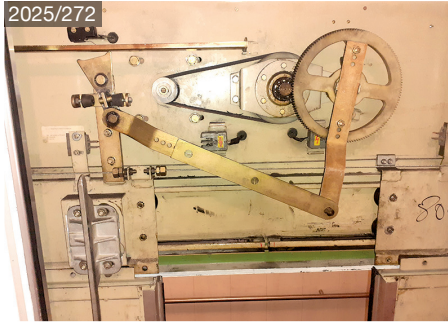

THYSSEN D6C Prisma center
2025/273

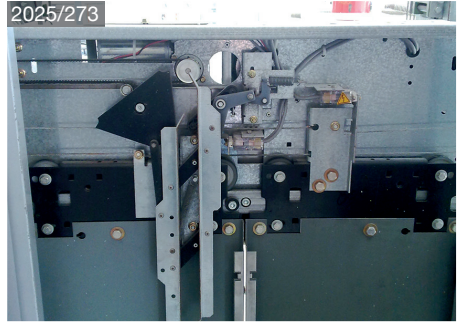

Thyssen D6C Prisma telescope
2025/274

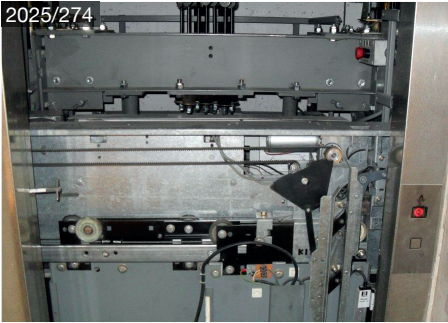

Thyssen D6C Schnecke center
2025/275

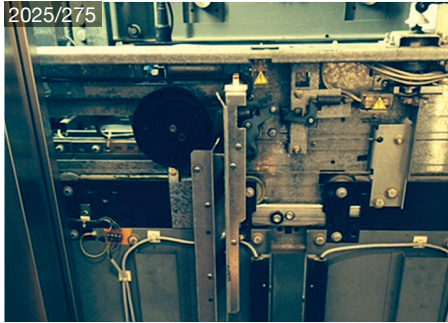

Thyssen D6C Schnecke telescope
2025/276



Thyssen ED015
2025/277

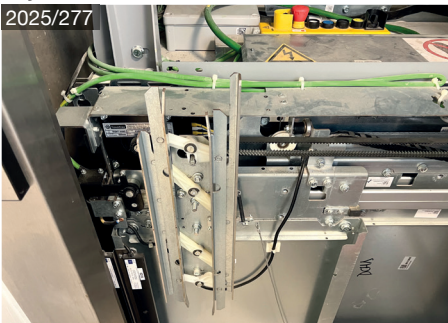

Thyssen F2 center
2025/278

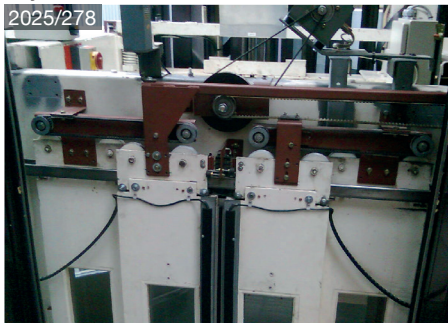

Thyssen F9 center
2025/279



Thyssen F9 telescope
2025/280



Thyssen F12 telescope
2025/281



Thyssen HD Harmonic Drive
2025/282



Thyssen LD-03 Linear Drive
2025/283



Thyssen M2T D4 telescope
2025/284

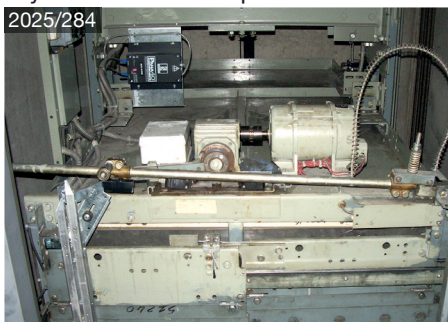

Thyssen M2T D6 telescope
2025/285

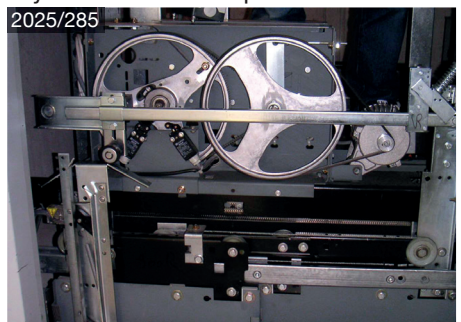

Thyssen M2T D11 telescope

2025/286

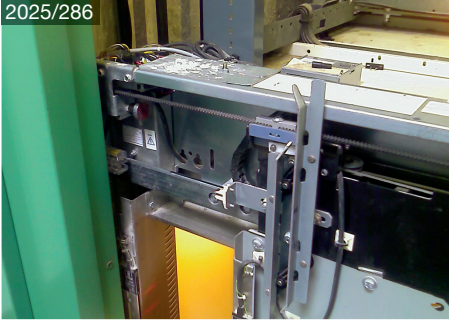

Thyssen M2T W1, G1, D1 telescope

2025/287

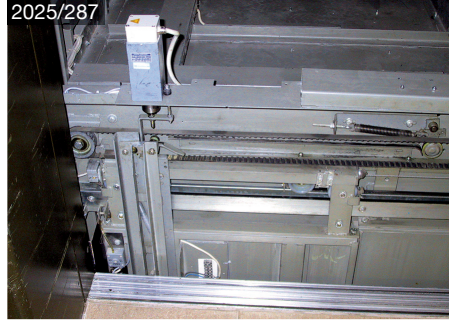

Thyssen M2Z chain center

2025/288

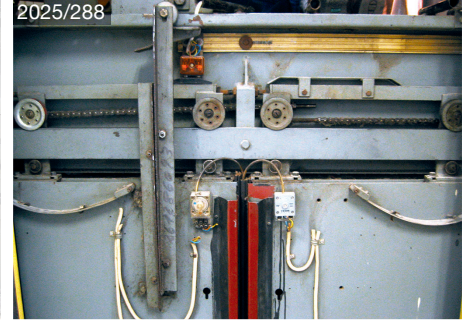

Thyssen M2Z D4 center

2025/289

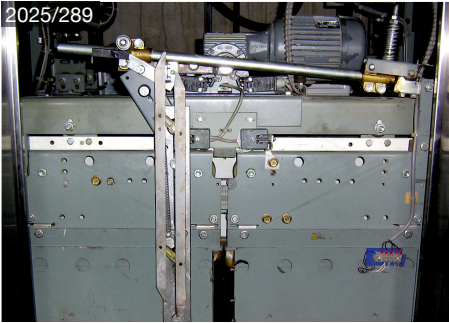

Thyssen M2Z D6 center

2025/290

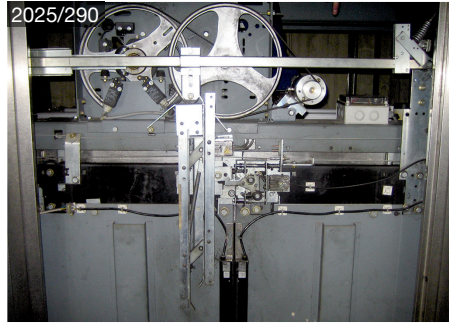

Thyssen M2Z W1, G1, D1 center

2025/291

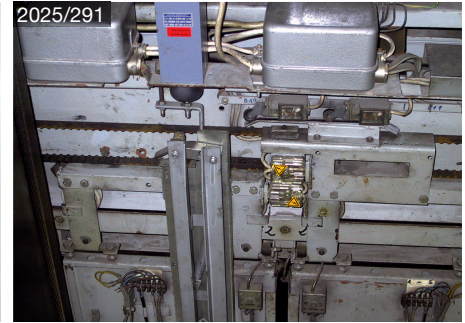

Thyssen M2Z W2 center

2025/292

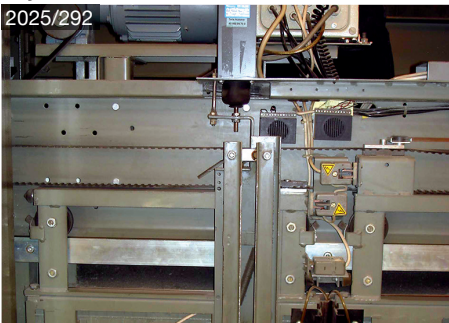

Thyssen M3TK telescope

2025/293



Thyssen M4Z W1, G1, D1 center

2025/294



Thyssen M6Z W1, G1, D1 center

2025/295



Thyssen RT300 center

2025/296

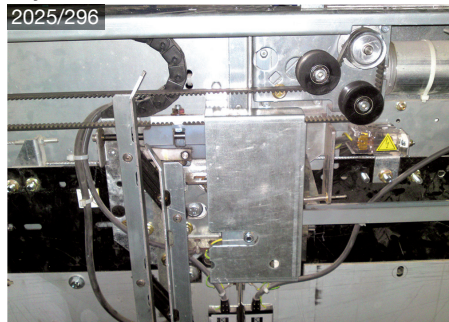

Thyssen RT301 telescope

2025/297

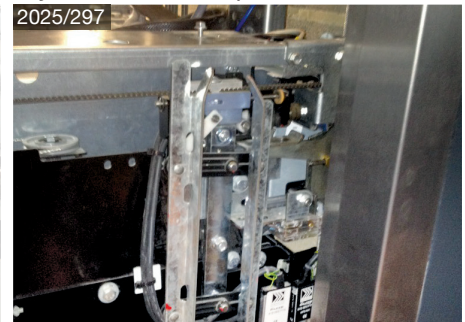

Thyssen VF08 center

2025/298

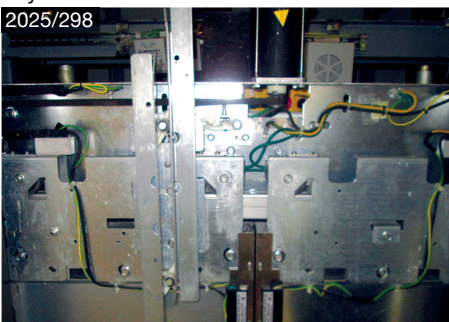

Thyssen VF08 telescope

2025/299

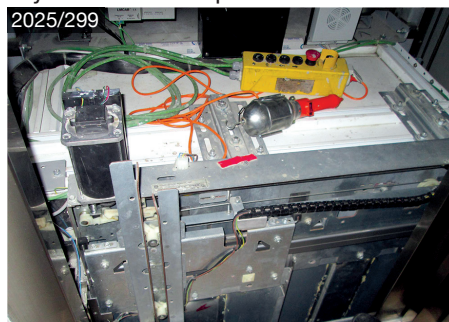

Thyssen VF11 telescope

2025/300

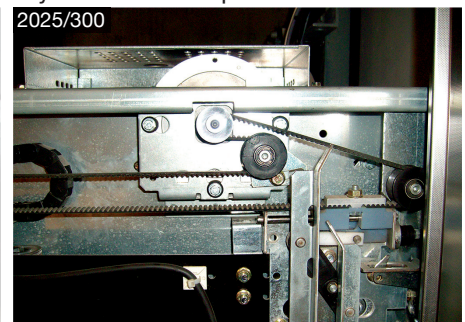

Thyssen VF400 telescope

2025/301

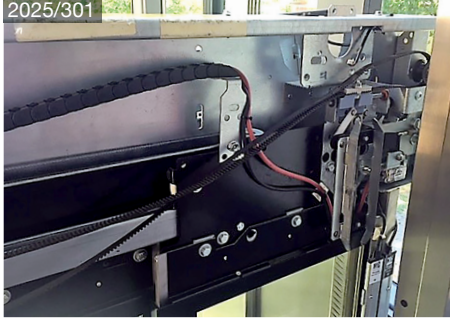

TOSHIBA center

2025/302

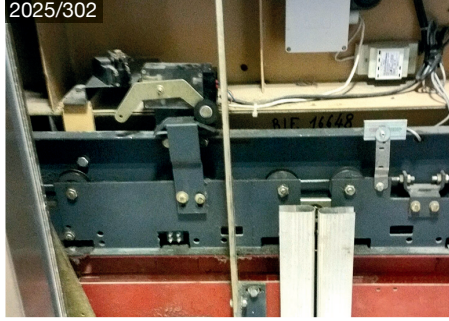

UNITEC AT400 Door Operator

2025/303



VESTNER telescope

2025/304

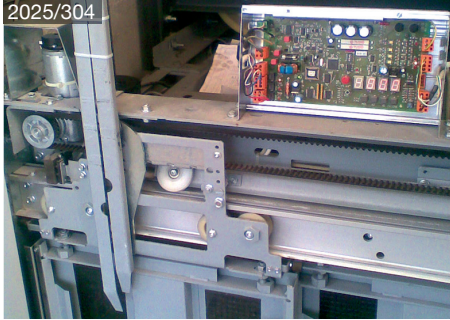

WALTER MAYER segment sliding door

2025/305

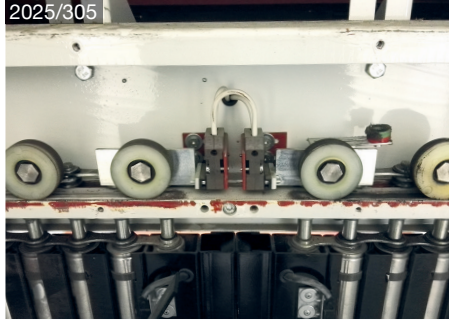

WEBER center

2025/306

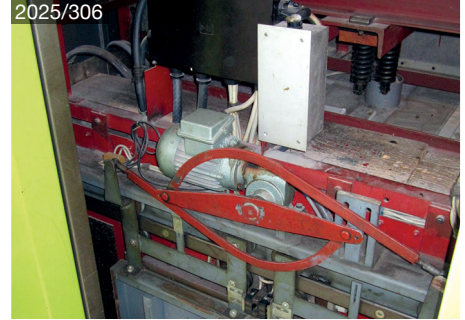

Weber telescope

2025/307

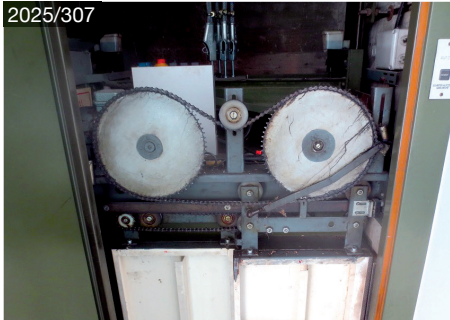

WEGAM telescope

2025/308

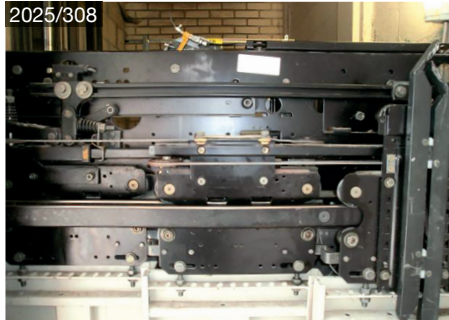

WERTHEIM telescope

2025/309



WESTINGHOUSE telescope

2025/310



WITTUR 3201 Sinus telescope

2025/311

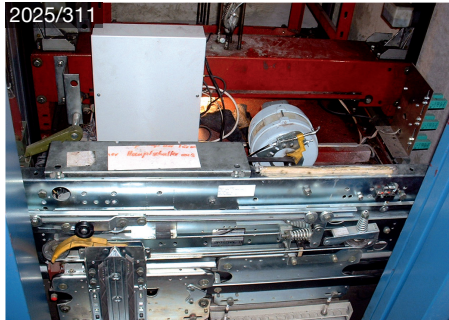

Wittur 3411 Eco Bus

2025/312

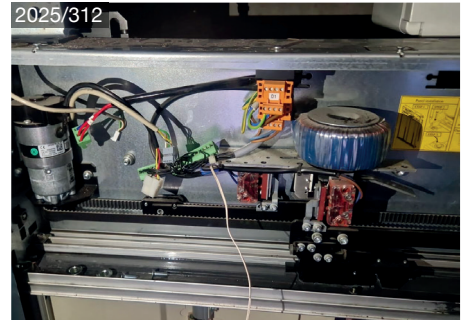

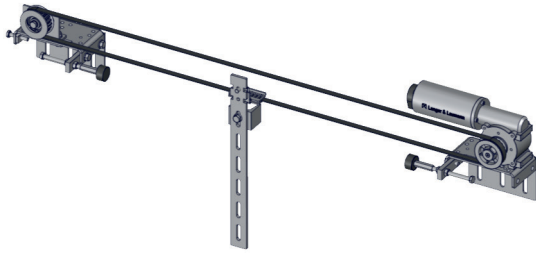

9.20.00400.04

TSG V4 400 Lift Door Operator universal kit

inclusive TSG V4 electronics, TSG motor, timing belt and brackets.

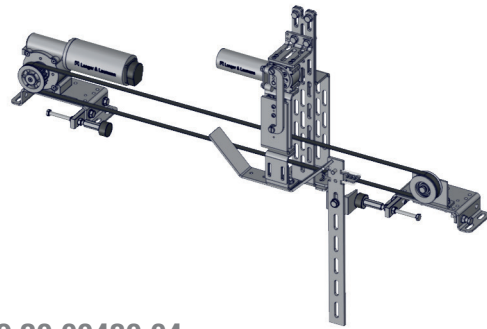

9.20.00480.04

TSG V4 400 Lift Door Operator universal kit

inclusive TSG Sinus Drive, TSG V4 electronics, TSG motor, timing belt and brackets.

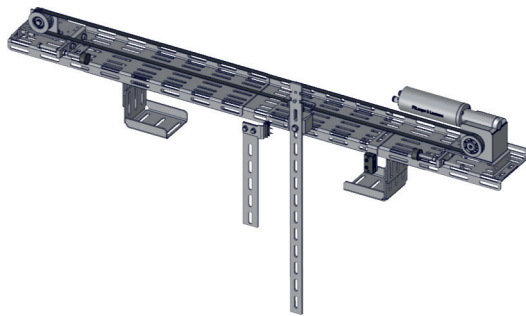

9.33.00400.04

TSG V4 400 Lift Door Operator Vario kit

inclusive TSG base plates for individual door width adaption, TSG V4 electronics, TSG motor, timing belt and brackets.

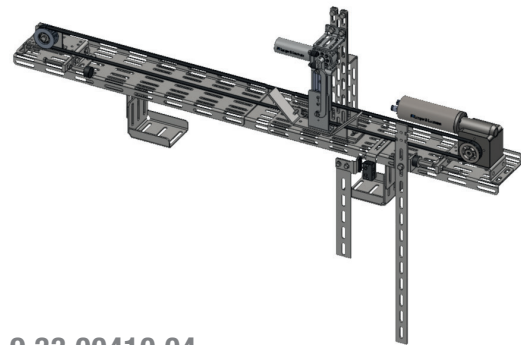

9.33.00410.04

TSG V4 400 Door Operator Vario kit

inclusive TSG Sinus Drive, base plates for individual door width adaption, TSG V4 electronics, TSG motor, timing belt and brackets.

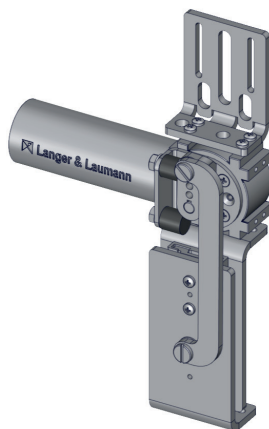

8.20.83111

TSG Sinus Drive left hand

for interlock or coupler operation.

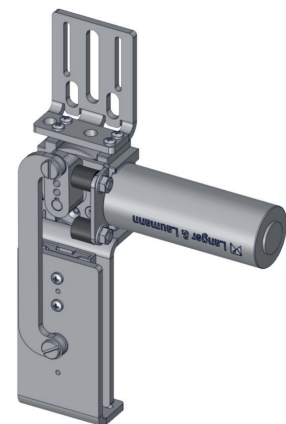

8.20.83112

TSG Sinus Drive right hand

for interlock or coupler operation.

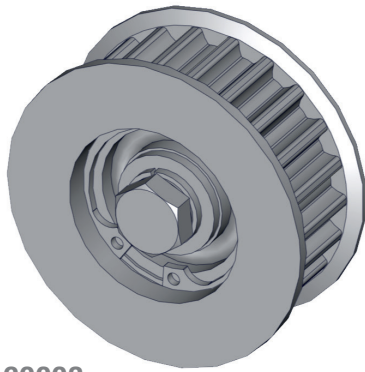

1.20.60003
TSG counter roller

standard

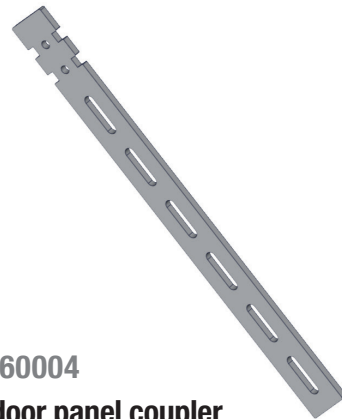

1.20.60004
TSG door panel coupler

standard

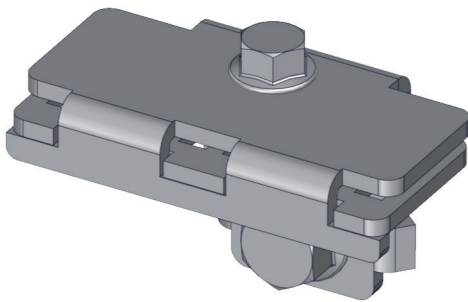

1.20.60005
TSG timing belt lock, steel

standard

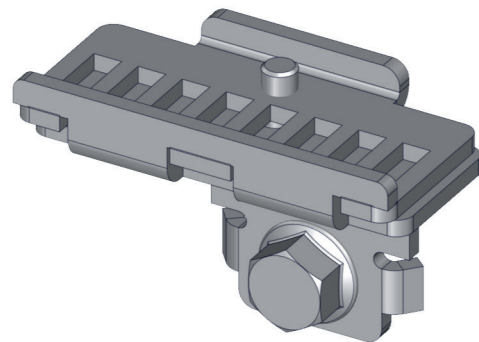

1.20.60007
TSG timing belt lock, steel

mirror image

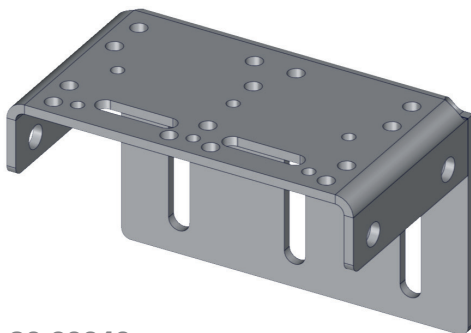

1.20.60040
TSG universal bracket

for fixing TSG 200 or 400 motor or counter roller

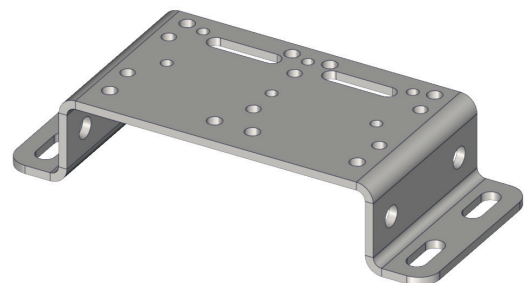

1.20.60060
TSG universal bracket, version „hat“

for fixing TSG 200 or 400 motor or counter roller



8.20.81521
TSG Easy Connection
reversing contactor circuit

Connection set for controlling the TSG V4 electronics via an existing reversing contactor circuit of a three-phase motor.



8.20.81540
TSG Easy Connection Miconic MX-GC

Connection set for controlling the TSG V4 electronics via the existing Schindler Miconic MX-GC lift controller



8.20.81545
TSG Easy Connection
Miconic BX (IVB20/DOD2)

Connection set for controlling the TSG V4 electronics via the existing Schindler Miconic BX (IVB20/DOD2) lift controller



8.20.81560
TSG Easy Connection wide-range voltage

Potential-free connection to a lift controller. The pre-wired connection box can be wired with signals between 10V and 250V (DC and AC).



8.20.81500
TSG Easy Connection basic

Universal connection set for power and signals. Inclusive cable, connecting clamps, cable ties.



8.20.81510
TSG Easy Connection duo box

Universal connection of two TSG V4 electronics.

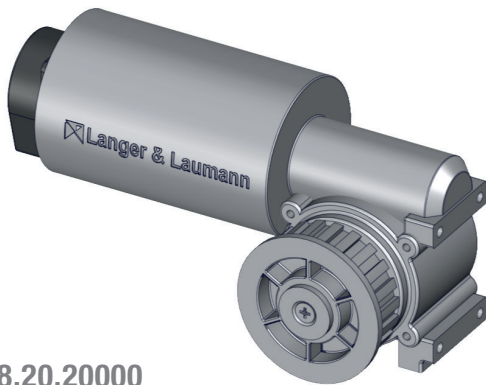

8.20.20000

TSG 200 motor left hand

inclusive timing belt pulley, encoder and cable,
for use up to a maximum weight of 200 kg.



8.20.20001

TSG 200 motor right hand

inclusive timing belt pulley, encoder and cable,
for use up to a maximum weight of 200 kg.

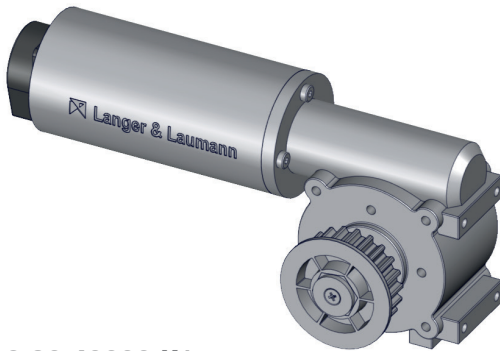

8.20.40000.K1

TSG 400 motor left hand

inclusive timing belt pulley, encoder and cable,
for use up to a maximum weight of 400 kg.

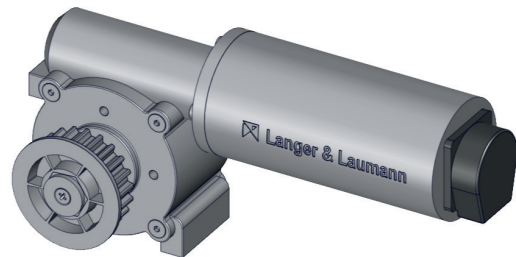

8.20.40001.K1

TSG 400 motor right hand

inclusive timing belt pulley, encoder and cable,
for use up to a maximum weight of 400 kg.

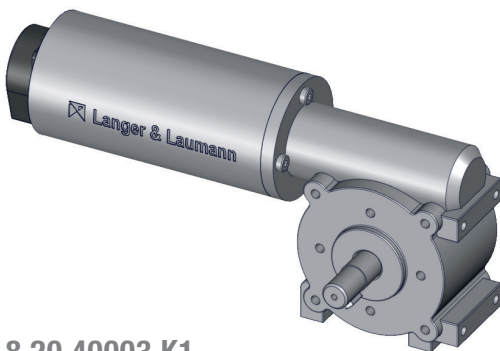

8.20.40003.K1

TSG 400 motor left hand

exclusive timing belt pulley, encoder and cable,
for use up to a maximum weight of 400 kg.

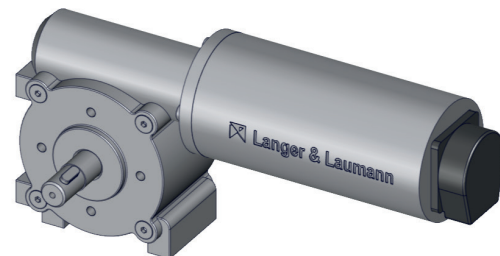

8.20.40002.K1

TSG 400 motor right hand

exclusive timing belt pulley, encoder and cable,
for use up to a maximum weight of 400 kg.

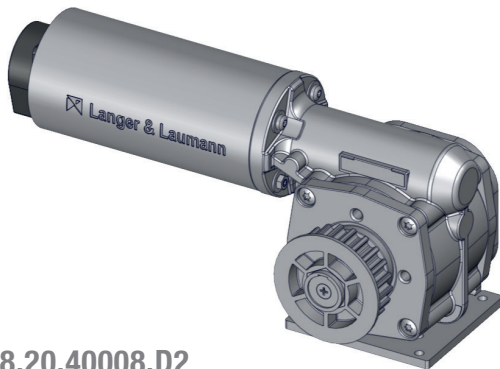

8.20.40008.D2

TSG 400 motor left hand

for AT25, inclusive timing belt pulley, encoder and cable, for use up to a maximum weight of 400 kg.

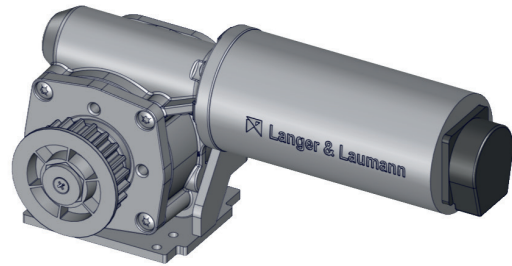

8.20.40009.D2

TSG 400 motor right hand

for AT25, inclusive timing belt pulley, encoder and cable, for use up to a maximum weight of 400 kg.



8.20.84000.K1

TSG 400 in EX ATEX

according to 2014/34/EU, inclusive encoder and cable, for use up to a maximum weight of 400 kg.



8.20.70050

TSG Webinterface

inclusive WLAN-router for easy connection to smartphone, tablet or laptop

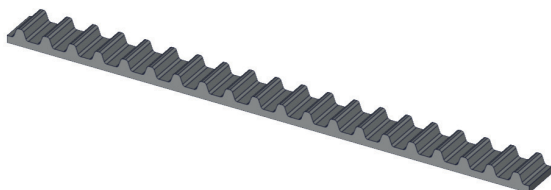

8.20.60002.X

TSG timing belt

in various lengths in stock

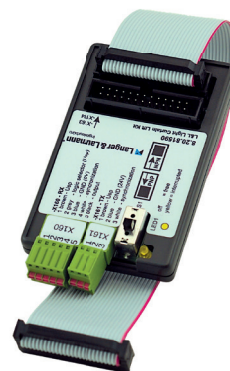

8.20.81590

TSG Easy Connection light curtain

Plug and Play adapter for connecting a light curtain to a L&L door control unit TSG V4 (min. Firmware 4.61.32).



FIND YOUR DOOR
www.lul-ing.de
Tel. +44 (0)1274 30 50 66



 **Langer & Laumann**[®]
smart door solutions

Head Office & Distribution worldwide

Langer & Laumann Ing.-Büro GmbH
Wilmsberger Weg 8
48565 Steinfurt, Germany
Tel. +49 (2552) 92 7 910

info@lul-ing.de | www.lul-ing.de